

Input: 100 Ω to 1 MΩ Potentiometers
Output: 0-1 V to ±10 VDC, or 0-1 mA to 0-20 mADC, 4-20 mA

- Accepts Most Full-Range Potentiometers
- Factory Ranged Voltage or Current Output
- Hot Swappable
- Full 2000 V Input/Output/Power Isolation
- Input and Output LoopTracker® LEDs
- Functional Output Test Button

Applications

- Over, Under, Out-of-Range Position Monitoring
- Remote Control of Positioning Devices
- Simplify Control of Potentiometer Outputs

Potentiometer Input Ranges

3 wire connection and full potentiometer travel is required
 Consult factory for other ranges and configurations
 1 VDC excitation provided to potentiometer

Minimum range: 0-100 Ω
 Maximum range: 0-1 MΩ

Input Impedance

100Ω to 1 MΩ minimum

Common Mode Rejection

100 dB minimum

LoopTracker

Variable brightness LEDs indicate I/O level and status

DC Output Range

Factory ranged, please specify output range and type

Voltage: 0-1 VDC to 0-10 VDC, 10 mA max
 including offset ranges such as 1-5 V

Bipolar voltage: ±1 VDC to ±10 VDC
 including offset ranges such as -1 to 4 V

Current: 0-1 mADC to 0-20 mADC
 including offset ranges such as 4- 20 mA
 20 V compliance, 1000 Ω at 20 mA

Calibration

Multi-turn zero and span potentiometers for output
 ±15% of span adjustment range typical

Output Loop Power Supply

20 VDC nominal, regulated, 25 mADC, max. ripple <10 mVrms
 Order EXTSUP option for unpowered mA output

Output Test

Sets output to test level when pressed
 Test level factory set to approx. 50% of span
 Call factory for custom setting

Output Ripple and Noise

Less than 10 mVrms

Linearity

Better than ±0.1% of span

Ambient Temperature Range and Stability

-10°C to +60°C operating ambient
 Better than ±0.02% of span per °C stability

Response Time

70 milliseconds typical

Isolation

2000 VRMS minimum
 Full isolation: power to input, power to output, input to output

Installation Environment

IP 40, requires installation in panel or enclosure
 Use with API 008 or API 008 FS socket
 Socket mounts to 35 mm DIN rail or can be surface mounted
 UL 508C pollution degree 2 environments or better

Power

Standard: 115 VAC ±10%, 50/60 Hz, 2.5 W max.
 A230 option: 230 VAC ±10%, 50/60 Hz, 2.5 W max.
 P option: 85-265 VAC 50/60 Hz, 60-300 VDC 2.5 W typ.
 D option: 9-30 VDC, 2.5 W typical

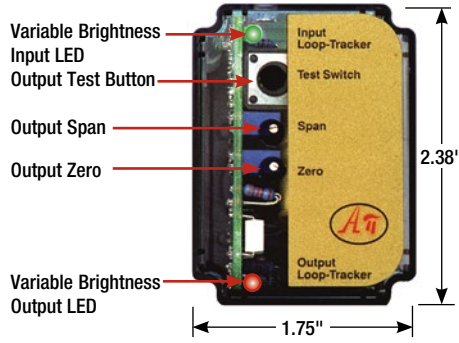

[Quick Link
api-usa.com/4003](http://api-usa.com/4003)

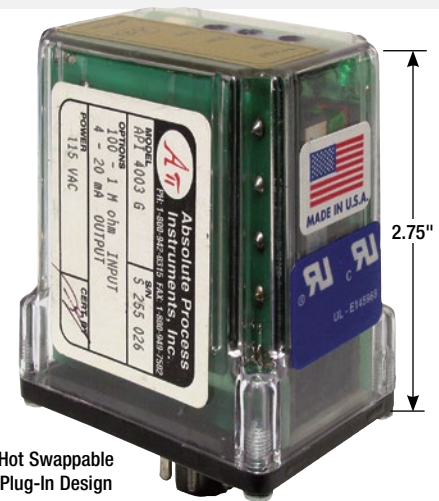

Hot Swappable
 Plug-In Design

 E145968
 115 VAC, 230 VAC
 models

**Free Factory
 I/O Setup!**

Description

The API 4003 G I accepts a resistance input from potentiometer, slidewire, linear position, displacement, or rotational devices and provides an optically isolated DC voltage or current output that is linearly related to the potentiometer position.

The API 4003 G I will accept any potentiometer with a value of 0-100 Ω through 0-1 MΩ without recalibration and without affecting accuracy.

The API 4003 G I output is factory ranged. Consult factory for offsets and/or input ranges other than 0 to 100% of the potentiometer range or see the APD 4008.

The full 3-way (input, output, power) isolation makes this module useful for ground loop elimination, common mode signal rejection, and noise pickup reduction.

Sink/Source Output Options

The API 4003 G I has a 20 VDC loop excitation supply for the output. This power supply can be used to power a passive mA device.

Order the API 4003 G I EXTSUP for an unpowered mA output for devices that are powered externally.

LoopTracker

API exclusive features include LoopTracker LEDs (green for input, red for output) that vary in intensity with changes in the process input and output signals.

They provide a quick visual picture of your process loop at all times and can greatly aid in saving time during initial startup and troubleshooting.



Output Test

An API exclusive feature includes an output test button to provide a fixed output (independent of the input) when held depressed. The output test greatly aids in saving time during initial startup and/or troubleshooting.

The test output level is factory set at 50% of output span.

Mounting

The API 4003 G I plugs into an industry standard 8-pin octal socket sold separately. Sockets API 008 and finger-safe API 008 FS allow either DIN rail or panel mounting.

Model	Input	Output	Power
API 4003 G I	Any full-range potentiometer from 0-100 Ohm to 0-1 Mega Ohm	Factory ranged specify output range in volts or mA	115 VAC 
API 4003 G I A230			230 VAC 
API 4003 G I P			85-265 VAC or 60-300 VDC
API 4003 G I D			9-30 VDC

Options—add to end of model number

- EXTSUP** Open collector output when a “sinking” output is required for an external loop supply
- U** Conformal coating for moisture resistance

Accessories—order as separate line item

- API 008** 8-pin socket
- API 008 FS** 8-pin finger-safe socket
- API CLP1** Module hold-down spring for high vibration or mobile applications



API 008 FS
 300 V Rating



API 008
 600 V Rating



API CLP1

Precautions

WARNING! All wiring must be performed by a qualified electrician or instrumentation engineer. See diagram for terminal designations and wiring examples. Consult factory for assistance.

WARNING! Avoid shock hazards! Turn signal input, output, and power off before connecting or disconnecting wiring, or removing or installing module.

Précautions

ATTENTION! Tout le câblage doit être effectué par un électricien ou ingénieur en instrumentation qualifié. Voir le diagramme pour désignations des bornes et des exemples de câblage. Consulter l'usine pour assistance.

ATTENTION! Éviter les risques de choc! Fermez le signal d'entrée, le signal de sortie et l'alimentation électrique avant de connecter ou de déconnecter le câblage, ou de retirer ou d'installer le module.

API maintains a constant effort to upgrade and improve its products. Specifications are subject to change without notice. See api-usa.com for latest product information. Consult factory for your specific requirements.

WARNING: This product can expose you to chemicals including lead and nickel, which are known to the State of California to cause cancer or birth defects or other reproductive harm. For more information go to www.P65Warnings.ca.gov

Socket and Mounting

The module installation requires a protective panel or enclosure. Use API 008 or finger-safe API 008 FS socket.

The socket clips to a standard 35 mm DIN rail or can be attached to a flat surface using the two mounting holes.

Electrical Connections

Polarity must be observed for output wiring connections. If the output does not function, check wiring and polarity.

Each product is factory configured to your exact input and output ranges as indicated on the serial number label.

Signal Input Terminals

The potentiometer must be connected to all three signal input terminals as shown. 0-100% of the potentiometer range must be used. The API 4003 G I utilizes a stable 1 VDC source to excite the potentiometer.

Potentiometer Input	Terminal
Zero or low end of potentiometer	4
Potentiometer wiper arm	5
Full scale or high side of potentiometer	6 (+1 VDC)

Signal Output Terminals

Polarity must be observed when connecting the signal output to the load. The positive connection (+) is connected to terminal 7 and the negative (-) is connected to terminal 8.

Note that with a current output the module provides power to the output loop unless option EXTSUP was ordered for a sinking output requirement.

Module Power Terminals

Check model/serial number label for module operating voltage to make sure it matches available power.

AC power is connected to terminals 1 and 3.

For DC powered modules, polarity **MUST** be observed.

Positive (+) is wired to terminal 1

Negative (-) is wired to terminal 3

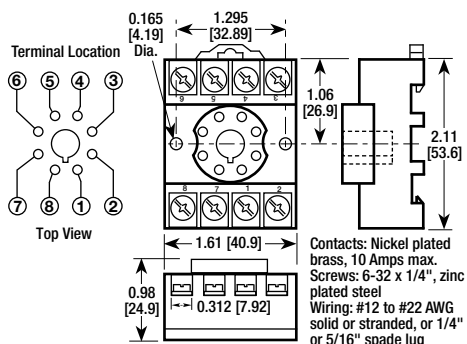

API 008 8-Pin Socket

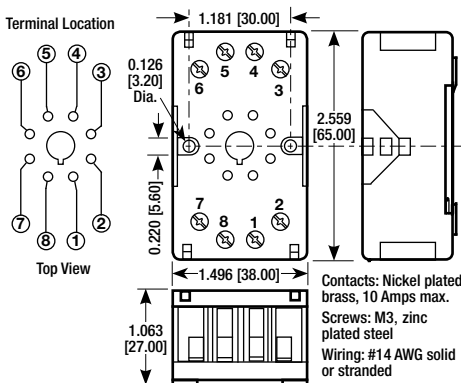
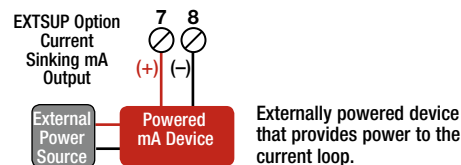
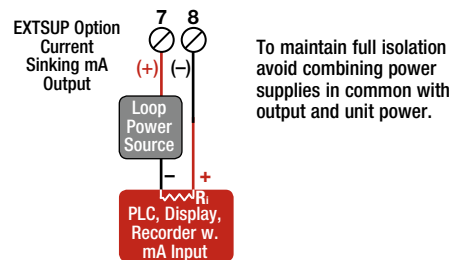
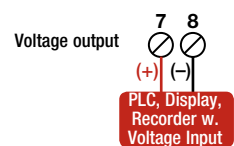
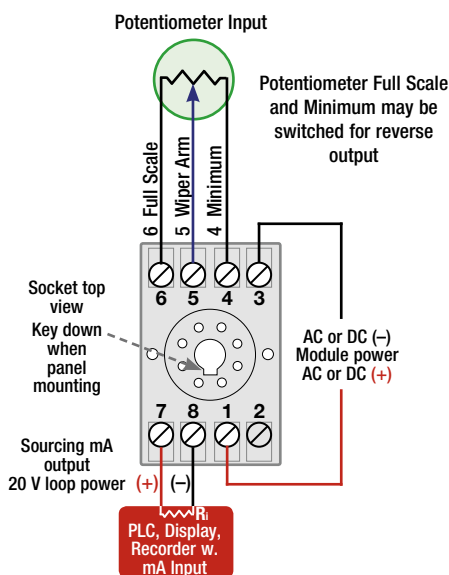

API 008 FS 8-Pin Finger Safe Socket

Calibration

The API 4003 G I comes from the factory calibrated to your specifications. Field calibration is typically not required, however, Zero and Span potentiometers are available to fine-tune the module output.

1. Apply power to the module and allow a minimum 20 minute warm up time.
2. Set the input potentiometer to its minimum value to provide a minimum input to the module.
3. Connect an accurate measurement device to the module output. Adjust the module's Zero potentiometer for the exact minimum output desired. The Zero control should only be adjusted when the input signal is at its minimum to produce the corresponding minimum output signal. For example: 4 mA for a 4-20 mA output or -10 V for a ±10V output.
4. Set the input potentiometer at its maximum, and then adjust the module's Span pot for the exact maximum output desired. The Span control should only be adjusted when the input signal is at its maximum. This will produce the corresponding maximum output signal. Example: for 4-20 mA output signal, the Span control will provide adjustment for the 20 mA or high end of the signal.
5. Repeat adjustments for maximum accuracy.

Output Test Function

When the Test button is depressed it will drive the output with a known good signal that can be used as a diagnostic aid during initial start-up or troubleshooting. When released, the output will return to normal.

The Test Cal. level is factory set to approximately 50% output. Example: If you are checking a 4-20 mA current loop, when the push button is held depressed, the output from the module will be approximately 12 mA.

Operation

The API 4003 G I utilizes a stable 1 VDC source to excite the potentiometer. This voltage is stabilized against the potentiometer resistance value variations over the entire operating range. The resulting potentiometer wiper voltage is amplified and passed through an optical coupler to the output stage where it is scaled to the desired output range.

The green LoopTracker® input LED provides a visual indication that a signal is being sensed by the input circuitry of the module. It also indicates the input signal strength by changing in intensity as the process changes from minimum to maximum. If the LED fails to illuminate, or fails to change in intensity as the process changes, check the module power or signal input wiring. Note that it may be difficult to see the LEDs under bright lighting conditions.

The red LoopTracker output LED provides a visual indication that the output signal is functioning. It becomes brighter as the input and the corresponding output change from minimum to maximum.

For current outputs, the red LED will only light if the output loop current path is complete. For either current or voltage outputs, failure to illuminate or a failure to change in intensity as the process changes may indicate a problem with the module power or signal output wiring.