

# Miniature Photo-Electric Sensors



- EASILY FITS MOST ANY MOUNTING SITUATIONS
- EXCEPTIONAL OPTICAL PERFORMANCE
- +10 to +30 VDC OPERATION WITH REVERSE POLARITY PROTECTION
- DISPLAY OPERATING STATUS LEDs ARE VISIBLE FROM 360°
- RUGGED SEALED HOUSING, PROTECTED CIRCUITRY
- LESS THAN 1 MILLISECOND OUTPUT RESPONSE FOR EXCELLENT SENSING REPEATABILITY

## GENERAL DESCRIPTION

These miniature self-contained and powerful Retroreflective, Proximity (Diffuse) and Opposed Beam Pair Photo-electric sensors provide application flexibility in counting, positioning and object detection. Their small size, in addition to various mounting options, greatly increases alignment ease and application possibilities.

All units can be powered by supplies ranging from +10 to +30 VDC and are reverse polarity protected. Green and amber LED's display operating status from 360 degrees, indicating "power on" and "light sensed". You can tell operating status of your sensors at a glance.

## MODELS EMDC2 & RCDC2 - OPPOSED BEAM EMITTER/ RECEIVER SENSOR PAIR

The Models EMDC2 (Emitter) and the RCDC2 (Receiver) are miniature, DC powered, Opposed Beam photo-electric sensor pairs with a 66' (20 M) sensing range. The Emitter contains a high power modulated "infrared" LED. The Receiver contains a sensitive photo-transistor and output transistor.

In operation, the output will turn on when the Receiver detects that an object has broken the Emitter beam. Due to their high gain, they are ideally suited for detecting opaque objects in dirty and dusty areas or when condensation or oil film environments are present.

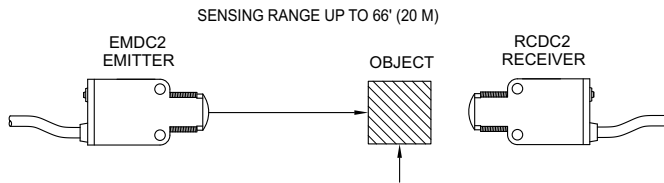

## MODEL RRDC2 - RETROREFLECTIVE SENSOR

The Model RRDC2 is a miniature, DC powered, retroreflective photo-electric sensor. The "visible" LED light beam allows for easy alignment and is modulated, to provide immunity to ambient light. The small beam size makes it a good choice for detecting relatively small objects.

In operation, the visible LED light beam is directed at a retro reflective target. An object breaking this beam will trigger the output.

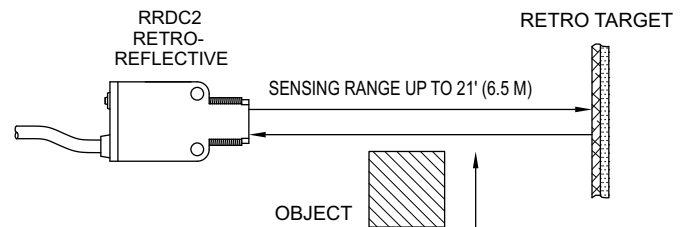

## MODEL PRDC2 - PROXIMITY SENSOR

The Model PRDC2 is a miniature, DC powered, Proximity (Diffuse) photo-electric sensor with a 18" (450 mm) maximum detecting distance. This sensor requires no special reflectors or reflective tapes and the limited sensing range reduces detection of background reflections. It is ideally suited for detection of transparent or translucent objects, parts ejected from presses, and rotating targets such as pulley spokes. A modulated "infrared" LED light beam provides immunity to ambient light.

In operation, the modulated light beam is reflected by the detected object. This reflected light beam is sensed by a photo-transistor, which in turn energizes the output. Actual sensing range is determined by the surface area and the amount of reflectivity of the object.

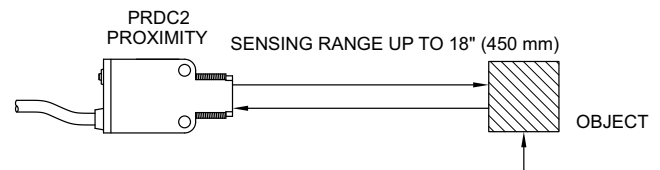

## SAFETY SUMMARY

All safety related regulations, local codes and instructions that appear in this literature or on equipment must be observed to ensure personal safety and to prevent damage to either the instrument or equipment connected to it. If equipment is used in a manner not specified by the manufacturer, the protection provided by the equipment may be impaired.

Do not use this unit to directly command motors, valves, or other actuators not equipped with safeguards. To do so can be potentially harmful to persons or equipment in the event of a fault to the unit. An independent and redundant temperature limit indicator with alarm outputs is strongly recommended.



**CAUTION: Risk of Danger.**  
 Read complete instructions prior to installation and operation of the unit.



**WARNING: Not To Be Used for Personnel Protection**  
 Never use this device as a sensing device for personnel protection. Doing so could lead to **serious injury or death.** This device does not include the self-checking redundant circuitry necessary to allow its use in personnel safety applications. A sensor failure or malfunction can cause either an energized or de-energized sensor output condition.

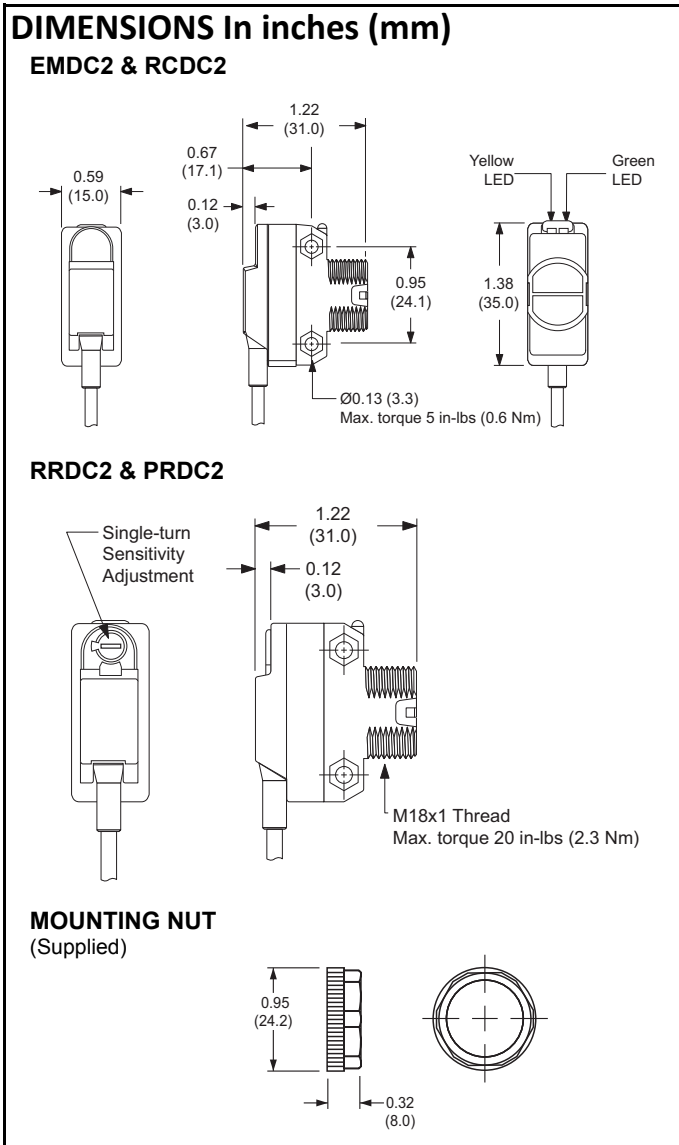

## SPECIFICATIONS

- SUPPLY VOLTAGE:** 10 to 30 VDC (10% maximum ripple) at less than 25 mA, exclusive of load  
 Protected against reverse polarity and transient voltages
- LIGHT SOURCE:**  
 Opposed and Diffuse mode models: Infrared, 940 nm  
 Retroreflective mode models: Visible red, 660 nm
- ADJUSTMENTS:**  
 Diffuse, and Retroreflective mode models: Single-turn sensitivity (Gain) adjustment potentiometer
- INDICATORS:**  
 2 LED indicators on sensor top:  
 Green solid: Power on  
 Amber solid: Light sensed  
 Green flashing: Output overloaded  
 Amber flashing: Marginal excess gain (1 to 1.5x excess gain)
- REQUIRED OVERCURRENT PROTECTION:**



**WARNING:** Electrical connections must be made by qualified personnel in accordance with local and national electrical codes and regulations.

Overcurrent protection is required to be provided by end product application per the supplied table.  
 Overcurrent protection may be provided with external fusing or via Current Limiting, Class 2 Power Supply.  
 Supply wiring leads < 24 AWG shall not be spliced.

SUPPLY WIRING	REQUIRED OVERCURRENT PROTECTION
20	5.0 A
22	3.0 A
24	2.0 A
26	1.0 A
28	0.8 A
30	0.5 A

- REPEATABILITY:**  
 Opposed Mode: 100 microseconds  
 Difuse and Retroreflective Mode: 150 microseconds
- OUTPUT CONFIGURATION:**  
 Solid-state NPN (current sinking)  
 Rating: 100 mA maximum at 25°C  
 Off-state Leakage Current: less than 50 µA @ 30 VDC  
 ON-state Saturation Voltage: less than 1 V @ 10 mA; less than 1.5 V @ 100 mA  
 Protected against false pulse on power-up and continuous overload or short circuit of output
- OUTPUT RESPONSE:**  
 Opposed Mode: 750 microseconds ON; 375 microseconds OFF  
 Difuse and Retroreflective Mode: 600 microseconds ON/OFF  
 Note: 100 millisecond delay on power-up; output does not conduct during this time
- CONSTRUCTION:**  
 ABS housing  
 3 mm mounting hardware included
- CONNECTIONS:** 2 m (6.5 ft) 4-wire PVC cable.
- ENVIRONMENTAL:**  
 IEC IP67; NEMA 6
- OPERATING CONDITIONS:**  
 Temperature: -4°F to 158°F (-20°C to 70°C)  
 Relative Humidity: 90% @ 50°C (non-condensing)
- CERTIFICATIONS:**  
 UL Recognized Component  
 (Banner Engineering QPS186 Series File #E71083)
- WEIGHT:** 2.0 oz (62.2 g)

## WIRING

### RCDC2, RRDC2, & PRDC2

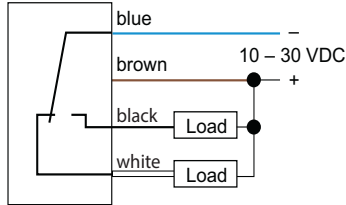

### EMDC2

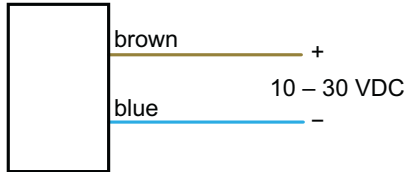

## PERFORMANCE CURVES

### Opposed Mode

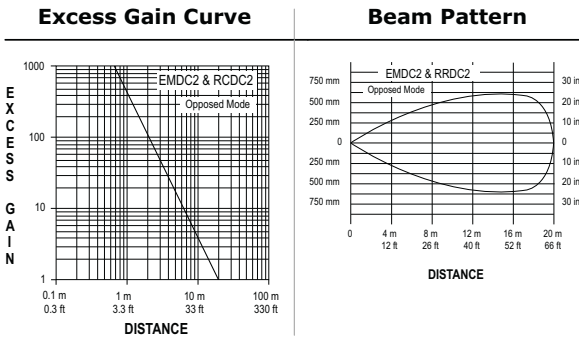

### Retroreflective Mode

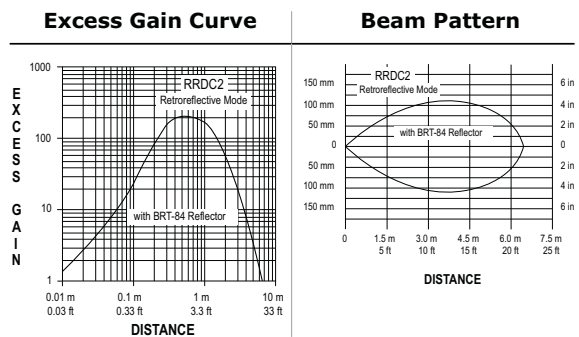

### Diffuse Mode

(Performance is based on a 90% reflectance white test card.)

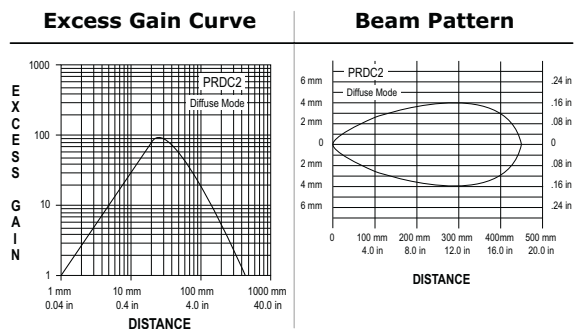

## SET-UP AND INSTALLATION

### USING THE PHOTOELECTRIC LED INDICATORS

The photoelectric has two bright LEDs; both are visible from 360 degrees. They indicate the following:

Green solid:	Power on
Amber solid:	Light sensed
Green flashing:	Output overloaded
Amber flashing:	Marginal excess gain (1 to 1.5x excess gain)

### SENSITIVITY ADJUSTMENT (RRDC2 & PRDC2 Only)

The unit features an extremely simple method for setting sensitivity (gain). Reduce gain by turning the pot counter-clockwise. If the gain is set too low, turn the pot clockwise to the appropriate level. Gain may be readjusted in this way at any time.

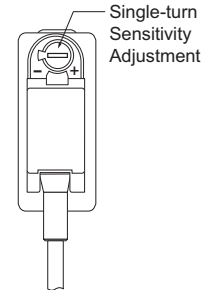

## BRACKET DIMENSIONS In inches (mm)

### MBMAB200

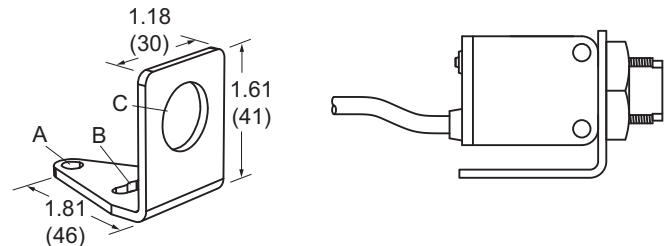

Hole center spacing: A to B = 0.95 (24.2)

#### Hole size:

- A =  $\varnothing$  0.18 ( $\varnothing$  4.6)
- B = 0.67 x 0.18 (17.0 x 4.6)
- C =  $\varnothing$  0.73 ( $\varnothing$  18.5)

### MBMSB200

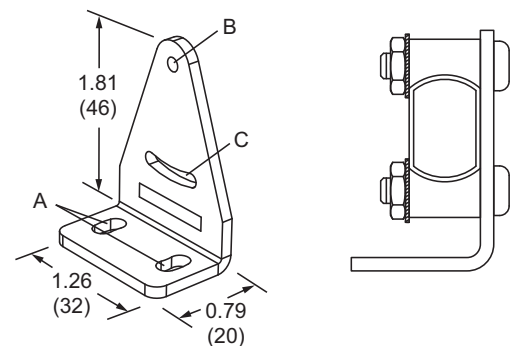

#### Hole size:

- A = 0.169 x 0.295 (4.3 x 7.5)
- B =  $\varnothing$  0.12 ( $\varnothing$  3)
- C = 0.118 x 0.602 (3 x 15.3)

## ORDERING INFORMATION

MODEL NO.	DESCRIPTION	PART NUMBER
EMDC2	DC Emitter (Opposed Beam Pair)	EMDC2000
RCDC2	DC Receiver (Opposed Beam Pair)	RCDC2000
RRDC2	Retroreflective DC Photo-Electric Sensor	RRDC2000
PRDC2	Proximity (Diffuse) DC Photo-Electric Sensor	PRDC2000
MBMA	Right-Angle Mounting Bracket	MBMAB200
MBMS	Side-Mount Mounting Bracket	MBMSB200
RT	1.5" Reflective Target	RT100000
	3" Reflective Target	RT200000
RRTAPE	50 mm x 2.5 m Reflective Tape	RRTAPE00

### LIMITED WARRANTY

(a) Red Lion Controls Inc., (the "Company") warrants that all Products shall be free from defects in material and workmanship under normal use for the period of time provided in "Statement of Warranty Periods" (available at [www.redlion.net](http://www.redlion.net)) current at the time of shipment of the Products (the "Warranty Period"). **EXCEPT FOR THE ABOVE-STATED WARRANTY, COMPANY MAKES NO WARRANTY WHATSOEVER WITH RESPECT TO THE PRODUCTS, INCLUDING ANY (A) WARRANTY OF MERCHANTABILITY; (B) WARRANTY OF FITNESS FOR A PARTICULAR PURPOSE; OR (C) WARRANTY AGAINST INFRINGEMENT OF INTELLECTUAL PROPERTY RIGHTS OF A THIRD PARTY; WHETHER EXPRESS OR IMPLIED BY LAW, COURSE OF DEALING, COURSE OF PERFORMANCE, USAGE OF TRADE OR OTHERWISE.** Customer shall be responsible for determining that a Product is suitable for Customer's use and that such use complies with any applicable local, state or federal law.

(b) The Company shall not be liable for a breach of the warranty set forth in paragraph (a) if (i) the defect is a result of Customer's failure to store, install, commission or maintain the Product according to specifications; (ii) Customer alters or repairs such Product without the prior written consent of Company.

(c) Subject to paragraph (b), with respect to any such Product during the Warranty Period, Company shall, in its sole discretion, either (i) repair or replace the Product; or (ii) credit or refund the price of Product provided that, if Company so requests, Customer shall, at Company's expense, return such Product to Company.

**(d) THE REMEDIES SET FORTH IN PARAGRAPH (c) SHALL BE THE CUSTOMER'S SOLE AND EXCLUSIVE REMEDY AND COMPANY'S ENTIRE LIABILITY FOR ANY BREACH OF THE LIMITED WARRANTY SET FORTH IN PARAGRAPH (a).**