

TECHNICAL DATA

# Fluke MDA-550 Series III Motor Drive Analyzer



**Simplify complex motor-drive troubleshooting with guided test setups and automated drive measurements that provide reliable, repeatable test results.**

The Fluke MDA 550 Motor-Drive Analyzer saves time and eliminates the hassle of setting up complex measurements, while simplifying motor-drive troubleshooting. Simply select a test and the step-by-step guided measurements show you where to make voltage and current connections, while the preset measurement profiles ensure you will capture all the data you need for each critical motor-drive section—from the input to the output, the DC bus, and the motor itself. From basic to advanced measurements, the MDA-550 has you covered, and with a built-in report generator you can quickly and easily generate as-found, and as-left reports with confidence.

The MDA-550 is the ideal portable motor-drive analysis test tool, and can help safely locate and troubleshoot typical problems on inverter type motor-drive systems.

- **Measure key motor-drive parameters** including voltage, current, DC Bus voltage level and AC ripple, voltage and current unbalance and harmonics, voltage modulation, and motor shaft voltage discharges.
- **Perform extended harmonics measurements** to identify the effects of low and high order harmonics on your electrical power system.
- **Conduct guided measurements** for motor-drive input, DC bus, drive output, motor input and shaft measurements with graphical step-by-step voltage and current connection diagrams.
- **Use simplified measurement setup** with preset measurement profiles to automatically trigger data collection based on the chosen test procedure.
- **Create reports quickly and easily** that are perfect for documenting troubleshooting and collaborative work with others.
- **Measure additional electrical parameters** with full 500 MHz oscilloscope, meter and recording capability for complete range of electrical and electronic measurement on industrial systems.

## KEY MEASUREMENTS

Inverter output voltage, DC bus voltage and ripple voltage, harmonics, unbalance

## THREE POWERFUL TEST TOOLS IN ONE

Motor-drive analyzer, waveform analyzer and recording data logger all in one

## HIGHEST SAFETY RATING IN THE INDUSTRY

600 V CAT IV/1000 V CAT III rated for use at the service entrance and downstream

## The Fluke MDA-550 Motor Drive Analyzer uses guided test measurements to make analysis easier than ever

### Drive input

Measure input voltage and current to quickly see whether values are within acceptable limits by comparing the drive's nominal rated voltage to the actual supplied voltage. Then, check the input current to determine if the current is within the maximum rating and the conductors are suitably sized. You can also check whether the harmonic distortion is within an acceptable level by visually inspecting the waveform shape or by viewing the harmonics spectrum screen which shows both the total harmonic distortion and individual harmonics.

### Voltage and current unbalance

Check the voltage unbalance at the input terminals so you can ensure the phase unbalance is not too high (> 6-8 %), and that the phase rotation is correct. You can also check the current unbalance, as excessive unbalance may indicate a drive rectifier problem.

### Extended harmonic measurements

Excessive harmonics are not just a threat to your rotating machines but also to other equipment connected to the electrical power system. The MDA-550 provides the ability to discover the harmonics of the motor-drive but can also discover the possible effects of inverter switching electronics. The MDA-550 has three harmonic ranges, 1st to 51st Harmonics, 1 to 9 kHz and 9 kHz to 150 kHz giving the ability to detect any harmonic pollution problems.

### DC bus

In a motor-drive the conversion of AC to DC inside the drive is critical, having the correct voltage and adequate smoothing with low ripple is required for the best drive performance. High ripple voltage may be an indicator of failed capacitors or incorrect sizing of the connected motor. The record function can be used to check DC bus performance dynamically in the operating mode while a load is applied.

### Drive output

Check the output of the drive focusing both on voltage to frequency ratio (V/F), and voltage modulation. When high V/F ratio measurements are experienced, the motor may overheat. With low V/F ratios, the connected motor may not be able to provide the required torque at the load to sufficiently run the intended process.

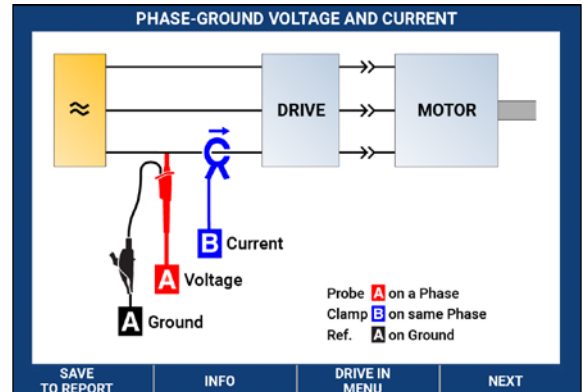

Drive input step-by-step guided measurement connections

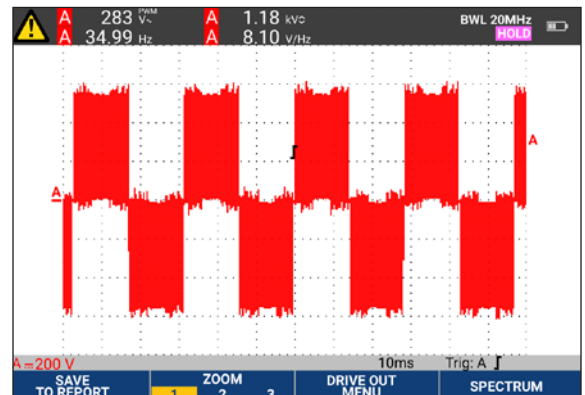

Drive output waveform with auto triggering

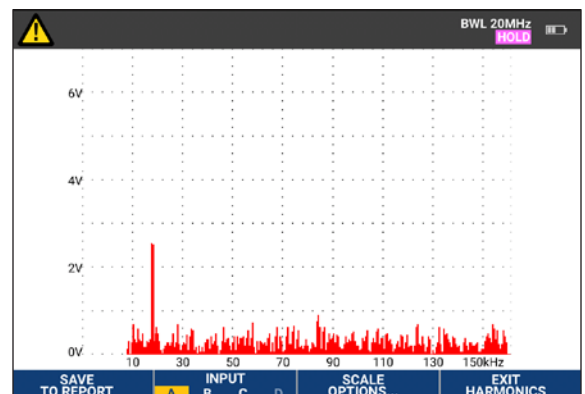

Extended harmonics spectrum from 9 kHz to 150 kHz

### Voltage modulation

Measurements of the Pulse Width Modulated signal are used to check for high voltage peaks which can damage motor winding insulation. The rise time or steepness of impulses is indicated by the  $dV/dt$  reading (rate of voltage change over time), this should be compared to the motor's specified insulation. The measurements can also be used to measure switching frequency to identify whether there is a potential issue with electronic switching, or with grounding, where the signal floats up and down.

### Motor input

Ensuring that voltage is being supplied at the motor input terminals is key, and the selection of cabling from drive to the motor is critical. Incorrect cabling selection can result in both drive and motor damage due to excessive reflected voltage peaks. Checking that the current present at the terminals is within the motor rating is important as over current condition could cause the motor to run hot, decreasing the life of the stator insulation which can result in the early failure of the motor.

### Motor shaft voltage

Voltage pulses from a variable speed drive can couple from a motor's stator to its rotor, causing a voltage to appear on the rotor shaft. When this rotor shaft voltage exceeds the insulating capacity of the bearing grease, flashover currents (sparking) can occur, causing pitting and fluting of the motor bearing race, damage that can cause a motor to fail prematurely. The MDA-550 is supplied with carbon fiber brush probe tips that can easily detect the presence of destructive flashover currents, while the impulse amplitude and count of events will enable you to take action before failure occurs. The addition of this accessory allows you to discover potential damage without investing in expensive permanently installed solutions.

### Step-by-step guided measurements ensure you have the data you need, when you need it

The MDA-550 is engineered to help you quickly and easily test and troubleshoot typical problems on three-phase and single-phase inverter type motor-drive systems. The on-screen information, and step-by-step setup guidance make it easy to configure the analyzer and get the drive measurements you need to make better maintenance decisions, fast. From power input to the installed motor, the MDA-550 provides the measurement capability for the fastest motor-drive troubleshooting.

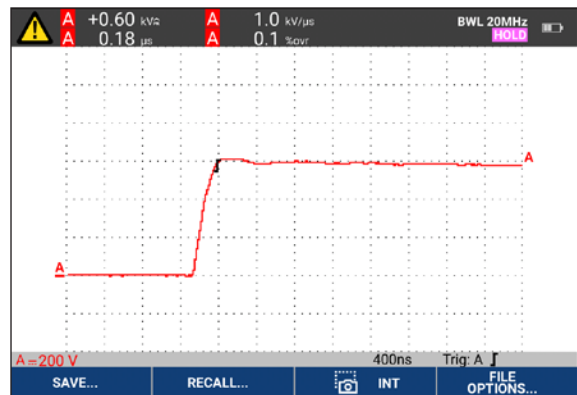

Voltage modulation with zoom

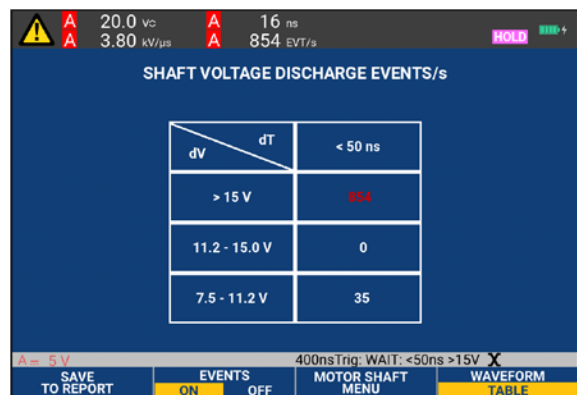

Motor shaft voltage discharge event counts

## Quick and easy measurement setup

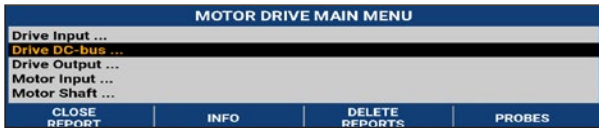

- 1) Press 'Motor Drive Analyzer' button and select 'Drive Measurement Location'.

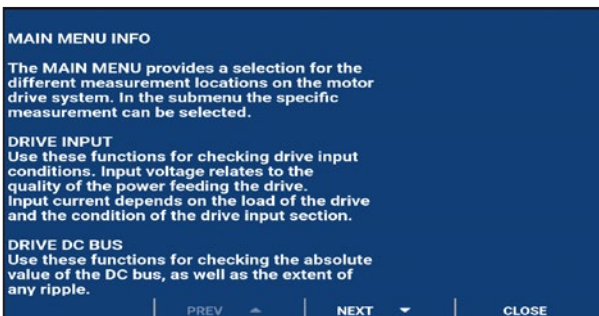

- 2) Use the on-screen context information to further guide you to successful setup and measurement.

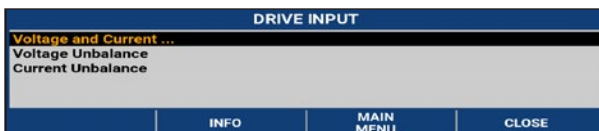

- 3) Choose the measurement.

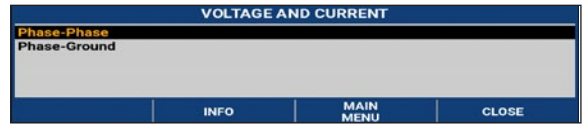

- 4) Select the measurement method/option.

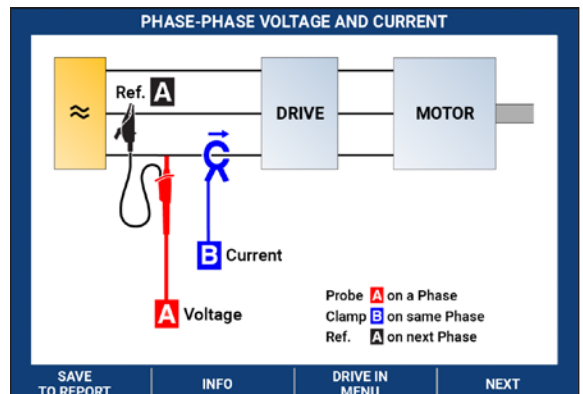

- 5) Connect the test probes according to the diagram. Once complete press 'Next'.

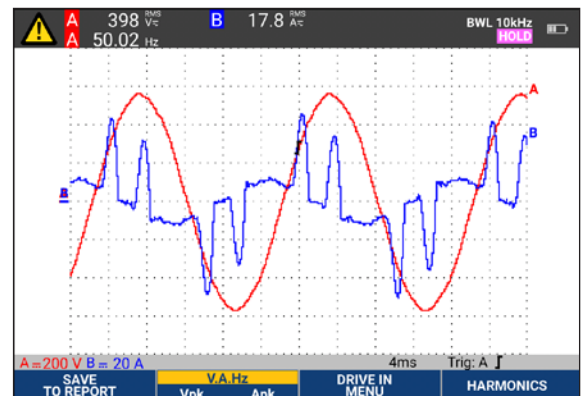

- 6) The analyzer will then automatically trigger, and configure the reading for the optimum measurements.

## Reporting and analysis

The MDA-550 simplifies the process of gathering data and writing test reports with a built-in report generator.

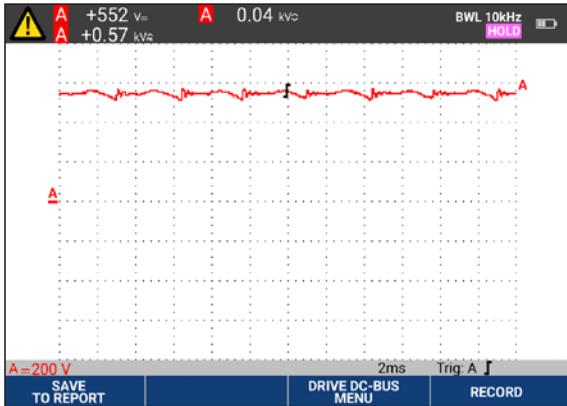

At each test point or measurement there is the option to create, update or modify a report. Simply press 'SAVE TO REPORT' and select the appropriate screens to save into a text based report file.

By performing the step-by-step guided measurements a comprehensive report can be created directly from the instrument to document the entire troubleshooting process.

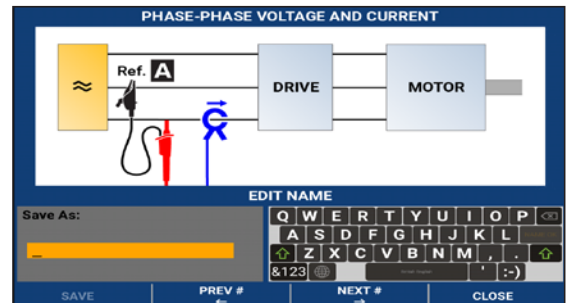

Input the report name. The single report encompasses all recorded measurements and can easily be shared with other users and used for motor-drive benchmarking, and for comparing data now and in the future.

## Featured measurements

<b>Measurement and Analysis Combinations</b>					
<b>Test point</b>	<b>Sub group</b>	<b>Reading 1</b>	<b>Reading 2</b>	<b>Reading 3</b>	<b>Reading 4</b>
<b>Motor drive input</b>					
Voltage and current					
Phase-phase	V-A-Hz	V ac+dc	A ac+dc	Hz	
	V peak	V peak max	V peak min	V pk-to-pk	Crest factor
	A peak	A peak max	A peak min	A pk-to-pk	Crest factor
Phase-ground	V-A-Hz	V ac+dc	A ac+dc	Hz	
	V peak	V peak max	V peak min	V pk-to-pk	Crest factor
	A peak	A peak max	A peak min	A pk-to-pk	Crest factor
Voltage unbalance	Unbalance	V ac+dc	V ac+dc	V ac+dc	Unbalance
	Peak	V pk-to-pk	V pk-to-pk	V pk-to-pk	
Current unbalance	Unbalance	A ac+dc	A ac+dc	A ac+dc	Unbalance
	Peak	A pk-to-pk	A pk-to-pk	A pk-to-pk	
<b>Motor drive DC bus</b>					
DC		V dc	V pk-to-pk	V peak max	
Ripple		V ac	V pk-to-pk	Hz	
<b>Motor drive output</b>					
Voltage and current (filtered)	V-A-Hz	V PWM	A ac+dc	Hz	V/Hz
	V peak	V peak max	V peak min	V pk-to-pk	Crest factor
	A peak	A peak max	A peak min	A pk-to-pk	Crest factor
Voltage unbalance	Unbalance	V PWM	V PWM	V PWM	Unbalance
	Peak	V pk-to-pk	V pk-to-pk	V pk-to-pk	
Current unbalance	Unbalance	A ac+dc	A ac+dc	A ac+dc	Unbalance
	Peak	A pk-to-pk	A pk-to-pk	A pk-to-pk	
Voltage modulation					
Phase-phase	Zoom 1	V PWM	V pk-to-pk	Hz	V/Hz
	Zoom 2	V peak max	V peak min	Delta V	
	Zoom 3 peak	V peak max	Delta V/s	Risetime peak	Overshoot
	Zoom 3 level	Delta V	Delta V/s	Risetime level	Overshoot
Phase-ground	Zoom 1	V PWM	V pk-to-pk	V peak max	V peak min
	Zoom 2	V Peak max	V peak min	Delta V	Hz
	Zoom 3 peak	V Peak max	Delta V/s	Risetime peak	Overshoot
	Zoom 3 level	Delta V	Delta V/s	Risetime level	Overshoot
Phase-DC +	Zoom 1	V PWM	V pk-to-pk	V Peak max	V peak min
	Zoom 2	V peak max	V peak min	Delta V	Hz
	Zoom 3 peak	V peak max	Delta V/s	Risetime peak	Overshoot
	Zoom 3 level	Delta V	Delta V/s	Risetime level	Overshoot
Phase-DC -	Zoom 1	V PWM	V pk-to-pk	V peak max	V peak min
	Zoom 2	V peak max	V peak min	Delta V	Hz
	Zoom 3 peak	V peak max	Delta V/s	Risetime peak	Overshoot
	Zoom 3 level	Delta V	Delta V/s	Risetime level	Overshoot

<b>Motor input</b>					
Voltage and current (filtered)	V-A-Hz	V PWM	A ac+dc	Hz	V/Hz
	V peak	V peak max	V peak min	V pk-to-pk	Crest factor
	A peak	A peak max	A peak min	A pk-to-pk	Crest factor
Voltage unbalance	Unbalance	V PWM	V PWM	V PWM	Unbalance
	Peak	V pk-to-pk	V pk-to-pk	V pk-to-pk	
Current unbalance	Unbalance	A ac+dc	A ac+dc	A ac+dc	Unbalance
	Peak	A pk-to-pk	A pk-to-pk	A pk-to-pk	
Voltage modulation					
Phase-phase	Zoom 1	V PWM	V pk-to-pk	Hz	V/Hz
	Zoom 2	V peak max	V peak min	Delta V	
	Zoom 3 peak	V peak max	Delta V/s	Risetime peak	Overshoot
	Zoom 3 level	Delta V	Delta V/s	Risetime level	Overshoot
Phase-ground	Zoom 1	V PWM	V pk-to-pk	V peak max	V peak min
	Zoom 2	V peak max	V peak min	Delta V	Hz
	Zoom 3 peak	V peak max	Delta V/s	Risetime peak	Overshoot
	Zoom 3 level	Delta V	Delta V/s	Risetime level	Overshoot
<b>Motor shaft</b>					
Shaft voltage	Events off	V pk-to-pk			
	Events on	Delta V	Rise/fall time	Delta V/s	Events/s
<b>Motor drive input, output and motor input</b>					
Harmonics	Voltage	V ac	V fundamental	Hz fundamental	% THD
	Current	A ac	A fundamental	Hz fundamental	% THD/TDD

## Specifications

Measurement Function	Specification
<b>DC voltage (V dc)</b>	
Maximum voltage with 10:1 or 100:1 probe	1000 V
Maximum resolution with 10:1 or 100:1 probe (voltage to ground)	1mV / 10mV
Full scale reading	999 counts
Accuracy at 4 s to 10 us/div	± (1.5 % + 6 counts)
<b>True-rms voltage (V ac or V ac + dc) (with DC coupling selected)</b>	
Maximum voltage with 10:1 or 100:1 probe (voltage to ground)	1000 V
Maximum resolution with 10:1 or 100:1 probe	1 mv / 10 mV
Full scale reading	999 counts
DC to 60 Hz	± (1.5 % + 10 counts)
60 Hz to 20 kHz	± (2.5 % + 15 counts)
20 kHz to 1 MHz	± (5 % + 20 counts)
1 MHz to 25 MHz	± ( 10 % + 20 counts)
<b>PWM voltage (V pwm)</b>	
Purpose	To measure on pulse width modulated signals, like motor drive inverter outputs
Principle	Readings show the effective voltage based on the average value of samples over a whole number of periods of the fundamental frequency
Accuracy	As Vac+dc for sinewave signals
<b>Peak voltage (V peak)</b>	
Modes	Max peak, min peak, or pk-to-pk
Maximum voltage with 10:1 or 100:1 probe (voltage to ground)	1000 V
Maximum resolution with 10:1 or 100:1 probe	10 mV
Accuracy	
Max peak, min peak	± 0.2 division
Pk-to-pk	± 0.4 division
Full scale reading	800 counts



<b>Current (AMP) with current clamp</b>	
Ranges	Same as V ac, Vac+dc or V peak
Scale Factors	0.1 mV/A, 1 mV/A, 10 mV/A, 20 mV/A, 50mV/A, 100 mV/A, 200 mV/A, 400 mV/A
Accuracy	Same as Vac, Vac+dc or V peak (add current clamp accuracy)
<b>Frequency (Hz)</b>	
Range	1.000 Hz to 500 MHz
Full scale reading	9999 counts
Accuracy	± (0.5 % + 2 counts)
<b>Voltage/Herz ratio (V/Hz)</b>	
Purpose	To show the measured V PWM value (see V PWM) divided by the fundamental frequency on variable ac motor speed drives
Accuracy	% Vrms + % Hz
<b>Voltage unbalance drive input</b>	
Purpose	To show the highest percentage difference of one of the phase vs average of the 3 true-rms voltages
Accuracy	Indicative percentage based on Vac+dc values
<b>Voltage unbalance drive output and motor input</b>	
Purpose	To show the highest percentage difference of one of the phase vs average of the 3 PWM voltages
Accuracy	Indicative percentage based on V PWM values
<b>Current unbalance drive input</b>	
Purpose	To show the highest percentage difference of one of the phase vs average of the 3 AC current values
Accuracy	Indicative percentage based on Aac+dc values
<b>Current unbalance drive output and motor input</b>	
Purpose	To show the highest percentage difference of one of the phase vs average of the 3 AC current values
Accuracy	Indicative percentage based on A ac values
<b>Rise and fall time</b>	
Readings	Voltage difference (dV), time difference (dt), voltage vs time difference (dV/dt), overshoot
Accuracy	As oscilloscope accuracy
<b>Harmonics and spectrum</b>	
Harmonics	DC to 51st
Spectrum ranges	1...9 kHz, 9-150 kHz (20 MHz filter on), up to 500 MHz (voltage modulation)
<b>Shaft voltage</b>	
Events / second	Indicative percentage based on rise and fall time (Impulse discharges) measurements
<b>Report data capture</b>	
Number of screens	Typical 50 screens can be saved in reports (depends on compression ratio)
Transfer to PC	Using 32 GB or smaller 2 GB USB stick or mini-USB to USB cable or WiFi link and FlukeView™ 2 for ScopeMeter®
<b>Probe settings</b>	
Voltage Probe	1:1, 10:1, 100:1, 1000:1, 20:1, 200:1
Current Clamp	0.1 mV/A, 1 mV/A, 10 mV/A, 20 mV/A, 50 mV/A, 100 mV/A, 200 mV/A, 400 mV/A
Shaft Voltage Probe	1:1, 10:1, 100:1

<b>Safety</b>	
General	IEC 61010-1: Pollution Degree 2
Measurement	Measurement IEC 61010-2-030: CAT IV 600 V / CAT III 1000 V
Maximum voltage between any Terminal and Earth Ground	1000 V
Max. input voltages	Via VPS410-II or VPS421 1000 V CAT III / 600 V CAT IV
BNC Input	A, B, C, D directly 300 V CAT IV
Max. Floating Voltage, test tool or test tool with VPS410-II / VPS421 voltage probe	From any terminal to earth ground 1000 V CAT III / 600 V CAT IV Between any terminal 1000 V CAT III / 600 V CAT IV
Working voltage between probe tip and probe reference lead	VPS410-II: 1000 V VPS421: 2000 V

## Ordering information

### MDA-550-III

Motor drive analyzer, 4 channel, 500 MHz

#### Includes

1x BP 291 li-ion battery pack, 1x BC190 charger/power adapter, 3x VPS421 100:1 high voltage probes with alligator clips, 1x VPS410-II-R 10:1 500MHz voltage probe, 3x i400s ac current clamp, 1x SVS-500 shaft voltage set (3x brush, probe holder, two-piece extension rod and magnetic base), large size, protective carrying case with rollers (C437-II), FlukeView-2 PC software (full version) and WiFi dongle

#### Additional accessories

**SVS-500** set of 3x brushes, probe holder, two-piece extension rod and magnetic base

**SB-500** set of 3x replacement brushes

\*In addition, Fluke 190 series III ScopeMeter™ Test Tools accessories are also supported by the MDA-550

**Fluke.** *Keeping your world up and running.*®

#### Fluke Corporation

PO Box 9090, Everett, WA 98206 U.S.A.

#### Fluke Europe B.V.

PO Box 1186, 5602 BD Eindhoven, The Netherlands

#### For more information call:

In the U.S.A. (800) 443-5853 or

Fax (425) 446-5116

In Europe/M-East/Africa +31 (0) 40 2675 200 or

Fax +31 (0) 40 2675 222

In Canada (800)-36-FLUKE or

Fax (905) 890-6866

From other countries +1 (425) 446-5500 or

Fax +1 (425) 446-5116

Web access: <http://www.fluke.com>

©2018, 2021 Fluke Corporation.

Specifications subject to change without notice.

Printed in U.S.A. 7/2021 210765-6011207-en

**Modification of this document is not permitted without written permission from Fluke Corporation.**